

QLINE DUAL-WATTAGE BATTEN

QLINE-WS-1500NW



LIGHTING & SECURITY



2760-3840
LUMENS

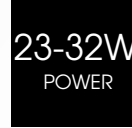

5YR
WARRANTY
1YR
ON-SITE



Driver as Standard



LED's inside

TECHNICAL DRAWINGS

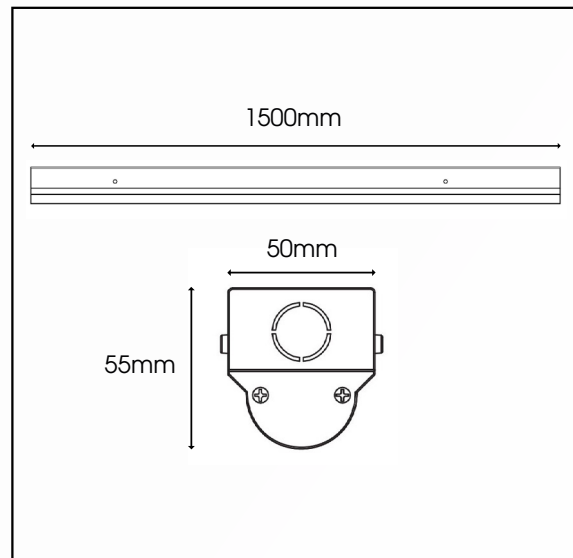

Specification	QLINE WS 1500
System Power	23-32W
LED Chipset	Epistar
Driver Manufacturer	Boke
Colour Rendering Index	>85
Lumen Output	2760 - 3840Lm
LED Efficacy	120 Lm/cW
Power Factor	0.9
IP Rating	IP20
Beam Spread	120 °
Colour Temperature	4000K
Housing Material	Aluminium
Diffuser Type	Polycarbonate
Operating Temperature	-20 to 50 °C
Input Voltage	AC 200-240V, 47-63Hz
Weight	1.2kg
Dimensions	1500mm x 50mm x 55mm
MacAdam Step	<3
Lifetime	50,000 hours, L70-B10 (Ta 25 °C)
CE Standard	EN60598-1, EN62493, EN55015, EN61547, EN61000-3-2, EN61000-3-3, EN62722-1, EN62722-2-1 and EN50581
CE Directives	LVD, EMC, ERP & RoHS

* Warranty terms and conditions apply

LUMINOUS INTENSITY DISTRIBUTION DIAGRAM

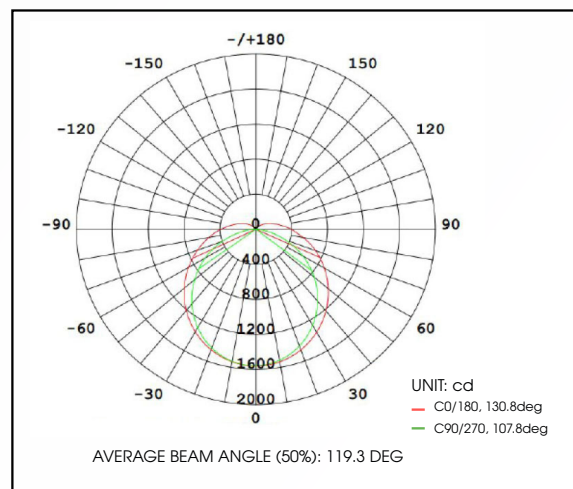

SURFACE & SUSPENDED RANGE