

Surface & Suspended



IP65 Ingress Protection



Screwless Design



Hinged Gear Tray



BESA Mounting Points

Dimensions



109mm

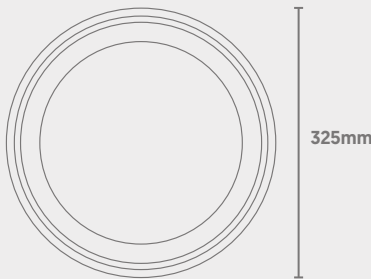

325mm



Light Source Energy Rating

Photometric Data

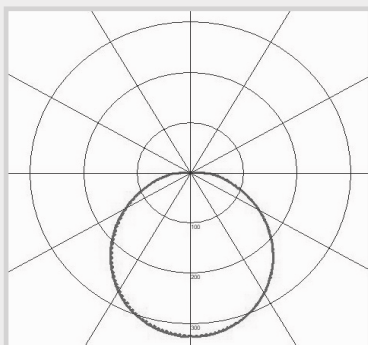

Taurus Gen 2

Tri-Colour Bulkhead

QVIS[®]
LED LIGHTING

CODE: TAU2-WS-325TC/MS



Microwave Sensor
Info on Following Pages



Power (Selectable)	Efficacy	Output	Kelvin
8W	105Lm/cW	840Lm	Tri-Colour: 3000K, 4000K or 6000K
12W	105Lm/cW	1260Lm	
15W	105Lm/cW	1575Lm	
18W	105Lm/cW	1890Lm	

Technical

Input Voltage	AC 220-240V
Beam Spread	120°
Colour Rendering Index	>80
Power Factor	>0.8
Operating Temp.	-20 to +40°C
Materials	Polycarbonate
IP Rating	IP65
IK Rating	IK10
Dimmable	Microwave Sensor
Dimensions	325mm x 109mm
Weight	0.89kg
MacAdam Step	<3
Lifetime	50,000 hours, L70-B10 (Ta 25 °C)
CE Standards	EN60598-1, EN62493, EN55015, EN61547, EN61000-3-2, EN61000-3-3, EN62722-1, EN62722-2-1 and EN50581
CE Directives	LVD, EMC, ERP & RoHS

Surface & Suspended

Taurus Gen 2

Microwave Sensor

QVIS[®]
LED LIGHTING

Dimensions

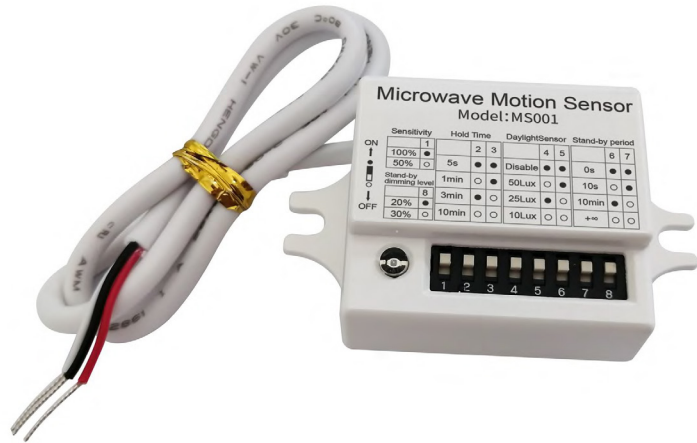
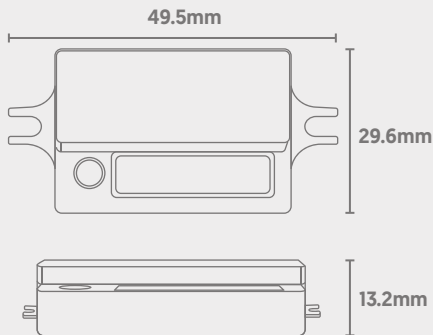

Technical

Input	Operating Voltage Range	11-15VDC
	Operating Current	22mA
Output	Output	10V PWM
Sensor Parameters	Microwave Frequency	5.8GHz±75MHz
	Microwave Power	<0.3mW
	Detection Angle	30° to 150°
	Sensitivity	100% / 50%
	Hold Time	5s / 1min / 3min / 10min
	Daylight Threshold	10Lx / 25Lx / 50Lx / Disabled
	Stand-By Period	0s / 10s / 10min / +∞
	Stand-By Dimming Level	20% / 30%
	Mounting Height	Max.6m (Ceiling Mounted); 1.5m to 1.8m (Wall Mounted)
	Detection Range	Max. 6m (Ceiling Mounted); Max .10m (Wall Mounted)
Operating Temperature	-35°C to +70°C	
Size	[L*W*H] 49.5mm x 29.6mm x3.2 mm	

Taurus Gen 2

Microwave Sensor

Dimensions

Detection Patterns

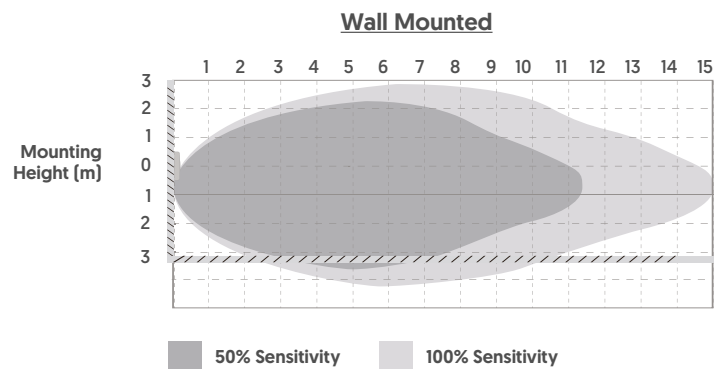
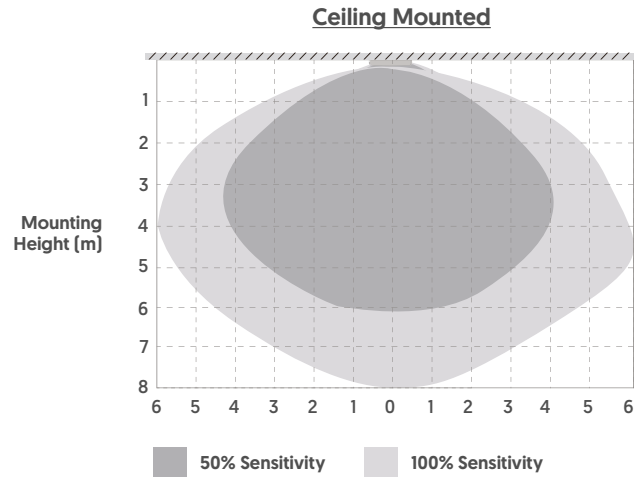

Dip-Switch Settings

Sensitivity		Hold-time		Daylight threshold		Stand-by period		Stand-by dimming level	
DIP switch	1	DIP switch	2 3	DIP switch	4 5	DIP switch	6 7	DIP switch	8
100%	●	5s	● ●	Disable	● ●	0s	● ●	20%	●
50%	○	1min	○ ●	50Lux	○ ●	10s	○ ●	30%	○
		3min	● ○	25Lux	● ○	10min	● ○		
		10min	○ ○	10Lux	○ ○	+∞	○ ○		

ON OFF

Sensitivity
In this area, movement will be detected and able to trigger the sensor. 100% detection area is also known as strong sensitivity.

Hold-time
The period that the light operates at 100% brightness after moving objects leave the detection area.

Daylight threshold
Amount of ambient brightness. The sensor will only operate when the ambient brightness is lower than the preset lux amount. On disable mode, the sensor will operate regardless of brightness levels.

Stand-by period
The period of time that the light stays at low output before it switches off completely. When the sensor is preset to '+∞', the light will remain at low output if there is no movement detected.

Stand-by dimming level
The dimming level during the standby period.

Taurus Gen 2

Microwave Sensor

On/Off Function (Stand-By Period is 0s)

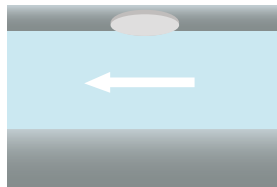

1) If ambient light is at a sufficient level, the light will remain off even if motion is detected.

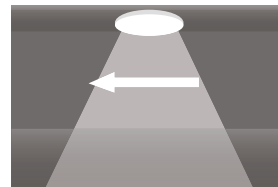

2) If ambient light is not sufficient, the light will switch on when motion is detected by the sensor.

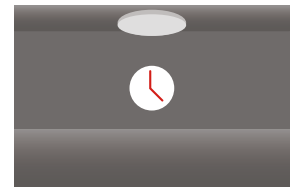

3) After hold-time elapses, the sensor will switch off the light if no motion is detected.

Daylight Threshold Set To 'Disabled'

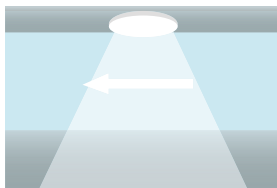

1) If motion is detected, the light will switch on.

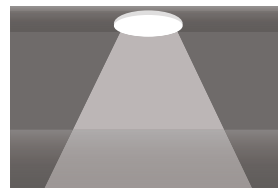

2) The sensor keeps the light on for the set hold time after the object leaves the detection area.

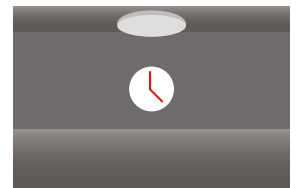

3) After hold-time elapses, the sensor will switch the light back off.

Corridor Function

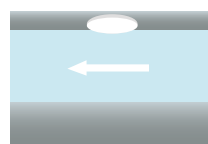

1) If ambient light is at a sufficient level, the light will remain off even if motion is detected.

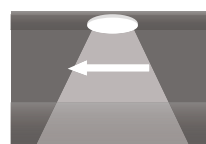

2) If ambient light is not sufficient, the light will switch on when motion is detected by the sensor.

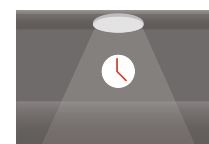

3) After hold-time elapses, the sensor will switch back to the preset low light level if no motion is detected.



4) After stand-by period elapses, the sensor will switch the light off if no motion is detected.

Taurus Gen 2

Microwave Sensor

Wiring Diagram*

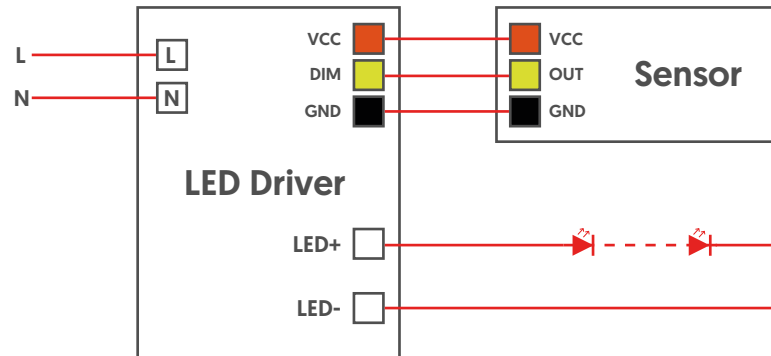

Important Notes

- 1) Wiring must be strictly in accordance with the wiring diagram to avoid short circuit.
- 2) Microwaves cannot penetrate metal. Do not place the sensor within an enclosed metal fitting or half-closed metal fitting. Metal or glass (thicker than 20mm) should not cover the sensor, as this will affect performance.
- 3) The sensor should be kept as far away from the driver as possible to avoid interference and unexpected light flashing.
- 4) Vibration signals may be picked up as moving signals, therefore triggering the sensor. Avoid placing the sensor near objects that vibrate regularly, such as metal equipment, pipes, air conditioning outlets, exhaust vents, smoke exhaust machine ports, shaking fans etc.
- 5) The sensor should be kept safe from hazards such as rain or wind (light fitting should have a high IP and IK rating if placed outside).