

## QStorm Pro

### Switchable Vapour Proof

CODE: QS-PRO-WS-1800TC/MS/EM

- High LED Efficacy
- IK08 Impact Resistance
- Wattage Switchable
- Tri-Colour (3000K/4000K/5700K)

#### Dimensions

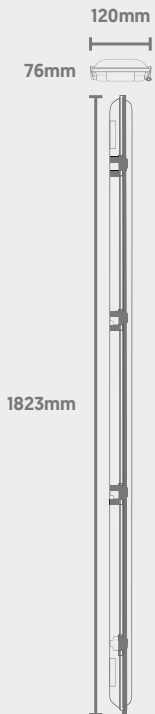

Microwave Sensor  
Info on Following Pages

Power [Selectable]	Efficacy	Output	Kelvin
35W [Emergency 3W]	170Lm/cW	5950Lm [Emergency 510Lm]	Tri-Colour: 3000K, 4000K or 5700K
44W [Emergency 3W]	170Lm/cW	7480Lm [Emergency 510Lm]	
53W [Emergency 3W]	170Lm/cW	9010Lm [Emergency 510Lm]	
62W [Emergency 3W]	170Lm/cW	10540Lm [Emergency 510Lm]	

### Technical

Input Voltage	AC 200-240V
Colour Rendering Index	>80
Beam Spread	120°
Power Factor	>0.9
Operating Temp.	-20 to +40°C
Materials	Polycarbonate
IP Rating	IP66
IK Rating	IK08
Dimmable	Microwave Sensor
Dimensions	1823mm x 120mm x 76mm
Weight	2.84kg
MacAdam Step	<3
Lifetime	3 Hours [3W]
Lifetime	50,000 hours, L90-B10 (Ta 25 °C)
CE Standards	EN60598-1, EN62493, EN55015, EN61547, EN61000-3-2, EN61000-3-3, EN62722-1, EN62722-2-1 and EN50581
CE Directives	LVD, EMC, ERP & RoHS

**Light Source Energy Rating**

### Photometric Data

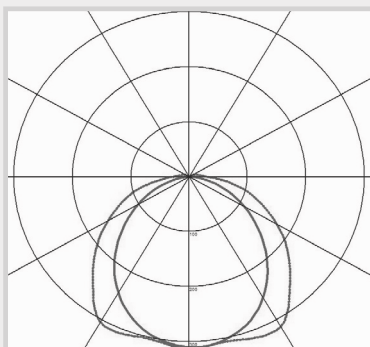

# QStorm Pro

## Microwave Sensor

### Dimensions

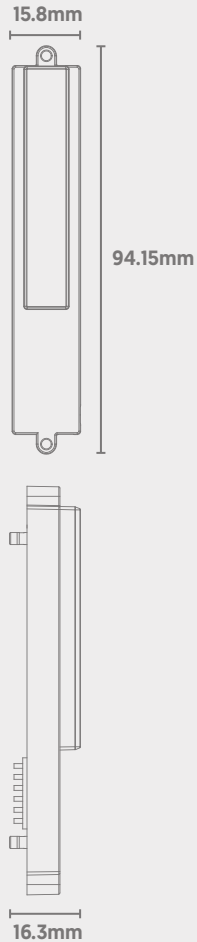

### Main Specifications

<b>Solution Type</b>	IC
<b>Input</b>	DC 12V
<b>Dimmable</b>	0-10V
<b>Controls</b>	DIP Switch & Remote Control
<b>Dimensions</b>	94.15mm x 15.8mm x 16.3mm

### Technical

<b>Operating Voltage</b>	10-15V
<b>Operating Current</b>	<30mA
<b>Stand-By Power</b>	<0.5W
<b>Switching Capacity</b>	<40mA Current
<b>Mounting Height</b>	2.5m to 4.5m [8.2ft. to 14.76ft.]
<b>Detection Height</b>	6m to 14m [19.68ft. to 45.93ft.]
<b>Connection</b>	3-Pin Output for VCC, GND, 0-10V
<b>Microwave Power</b>	<0.3mW
<b>Microwave Frequency</b>	5.8GHz±75MHz
<b>Detection Area</b>	DIP Switch: 50% / 100%
	Remote: 25% / 50% / 75% / 100%
<b>Hold-Time</b>	DIP Switch: 5s / 30s / 1min / 10min
	Remote: 5s / 30s / 1min / 10min / 20min / 30min
<b>Daylight Threshold</b>	DIP Switch: 50Lx / Disabled
	Remote: 2Lx / 10Lx / 15Lx / 50Lx / 80Lx / 120Lx / Disabled
<b>Stand-By Period</b>	DIP Switch: 0s / 1min
	Remote: 0s / 10s / 30s / 1min / 5min / 10min / 20min / 30min / +∞
<b>Stand-By Dimming Level</b>	DIP Switch: 10% / 30%
	Remote: 10% / 20% / 30% / 50%
<b>Detection Angle</b>	Side Wall: <150°
	Ceiling Mounted: 360°
<b>Factory Default</b>	Detection Area: 100%
	Hold Time: 5s
	Daylight Threshold: Disabled
	Stand-By Period: 0s
	Stand-By Dimming Level: 10%

# QStorm Pro

## Microwave Sensor

### Function Overview

#### On/Off Function (Stand-By Period is 0s)



1) If ambient light is at a sufficient level, the light will remain off even if motion is detected.

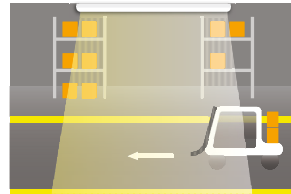

2) If ambient light is not sufficient, the light will switch on when motion is detected by the sensor.

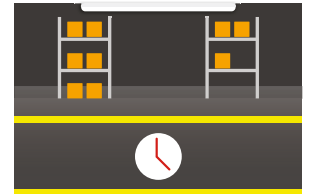

3) After hold-time elapses, the sensor will switch off the light if no motion is detected.

#### Daylight Threshold Set To 'Disabled'

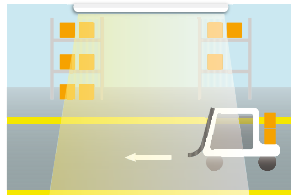

1) If motion is detected, the light will switch on.

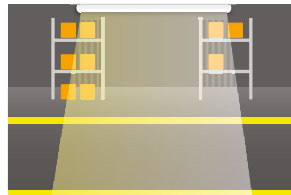

2) The sensor keeps the light on for the set hold time after the object leaves the detection area.

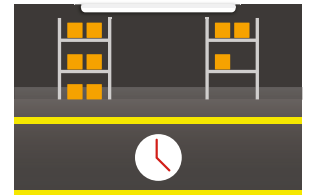

3) After hold-time elapses, the sensor will switch the light back off.

#### Corridor Function (2 Level Dimming)

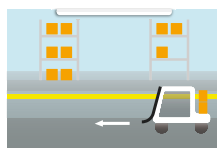

1) If ambient light is at a sufficient level, the light will remain off even if motion is detected.



2) If ambient light is not sufficient, the light will switch on when motion is detected by the sensor.

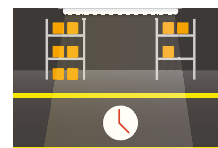

3) After hold-time elapses, the sensor will switch back to the preset low light level if no motion is detected.

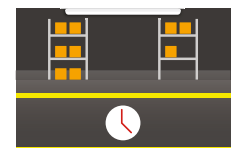

4) After stand-by period elapses, the sensor will switch the light off if no motion is detected.

# QStorm Pro

## Microwave Sensor

### Wiring Diagram\*

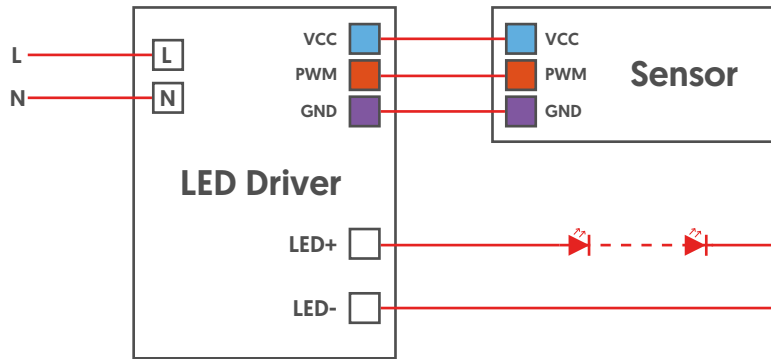

**VCC** = DC 12V Input  
**PWM** = 0/10V DIM+  
**GND** = 0/10V DIM-

### Detection Patterns

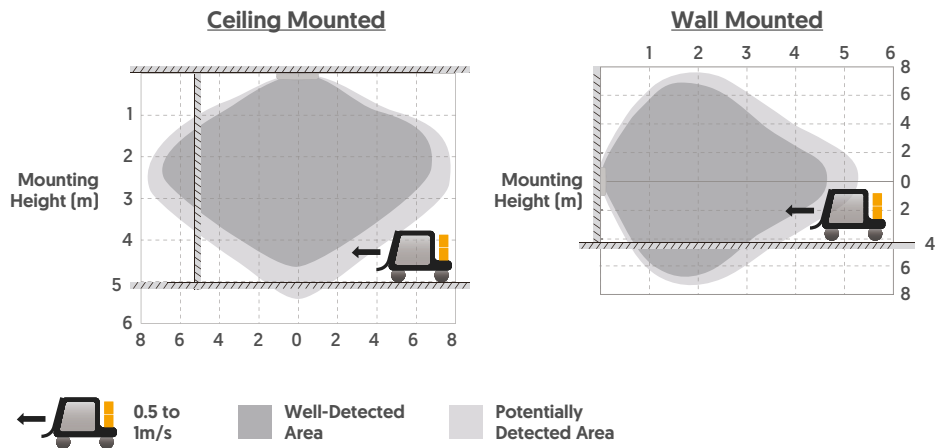

The highest mounting height is ideally 4.5m for optimal detection [see dark grey areas]. This figure indicates 100% sensitivity.

# QStorm Pro

## Microwave Sensor

### DIP Switch Settings

**SWITCH UP** (filled circle)  
**SWITCH DOWN** (open circle)

**Stand-By Dimming Level**

<input checked="" type="radio"/>	10%
<input type="radio"/>	30%

The dimming level of low output during the stand-by period.

**Stand-By Period**

<input checked="" type="radio"/>	0s
<input type="radio"/>	1min

The period that the light stays at lowest output before it completely switches off. When the preset is set to '+∞', the light will always stay at low output when no motion is detected and will not turn off.

**Daylight Threshold**

<input checked="" type="radio"/>	Disable
<input type="radio"/>	50Lx

The level of ambient brightness threshold. When ambient brightness is below the preset lux amount, the sensor will operate. If set to 'disabled', the sensor will operate on motion detection regardless of ambient brightness levels.

**Hold Time**

<input checked="" type="radio"/>	<input checked="" type="radio"/>	5s
<input checked="" type="radio"/>	<input type="radio"/>	10s
<input type="radio"/>	<input checked="" type="radio"/>	1min
<input type="radio"/>	<input type="radio"/>	10min

The period of time that the light stays at 100% brightness once the detected object/person leaves the detection area.

**Detection Area**

<input checked="" type="radio"/>	100%
<input type="radio"/>	50%

In the specified detection area, movement will trigger the sensor. 100% detection is also known as 'strong sensitivity'.

# QStorm Pro

## Microwave Sensor

### Factory Settings

- **Detection Area: 100%**
- **Hold Time: 5s**
- **Stand-By Period: 0s**
- **Daylight Threshold: Disabled**
- **Stand-By Dimming Level: 10%**

### Important Notes

- 1)** The sensor should only be installed by a qualified electrician.
- 2)** Power must be off before any installation, wiring, or changing of DIP switch settings takes place.
- 3)** Microwaves cannot penetrate metal. Do not place the sensor within an enclosed metal fitting or half-closed metal fitting. Metal or glass (thicker than 20mm) should not cover the sensor, as this will affect performance.
- 4)** The distance between the sensor and any other sensors should be greater than 3m. Keep the sensor away from switches, routers and other wireless devices that may interfere, in order to avoid radio interference.
- 5)** Vibration signals may be picked up as moving signals, therefore triggering the sensor. Avoid placing the sensor near objects that vibrate regularly, such as metal equipment, pipes, air conditioning outlets, exhaust vents, smoke exhaust machine ports, shaking fans etc.
- 6)** The light sensitivity threshold is a daylight environment, with no shadow and ambient light diffusion reflections. Ambient lux levels could be compatible to various environments (weather, climate, time-of-day).
- 7)** Wiring must be strictly in accordance to the diagram provided to avoid short circuit.
- 8)** Keep a good distance from the driver in order to avoid interference.
- 9)** Testing should be conducted on sunny days with no lampshade in order to get an accurate lux value reading.